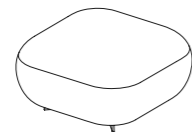
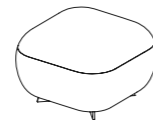


# CODE OUT

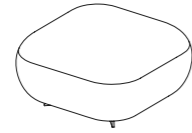
Parisotto+Formenton



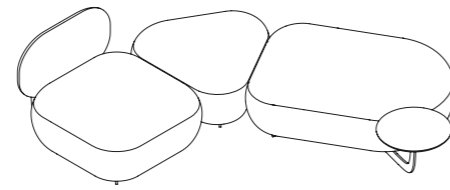
**LOUNGE**  
75 cm



**POUF**  
60 cm



**SINGLE**  
SINGOLO - SINGLE



**LINKED**  
COLLEGATO - LIÉ

## COLORS AND MATERIALS

COLORI E MATERIALI - COULEURS ET MATÉRIAUX

### STEEL FEET / TRAY TABLE LEG

PIEDINI IN ACCIAIO / SUPPORTO TAVOLINO - PIEDS EN ACIER / SUPPORT EN ACIER



Click on the icon to see the standard RAL finishings for the steel bases on the dedicated page. Customized RAL colors finishings are available upon request.

Clicca sull'icona per vedere le finiture RAL standard delle basi in acciaio sulla pagina dedicata. Su richiesta sono disponibili colorazioni customizzate su altre tinte RAL.

Cliquez sur l'icône pour voir les finitions RAL standard des bases en acier sur la page dédiée. Des couleurs RAL personnalisées sont disponibles sur demande.

### HPL TABLE

TAVOLINO IN HPL - TABLE EN HPL



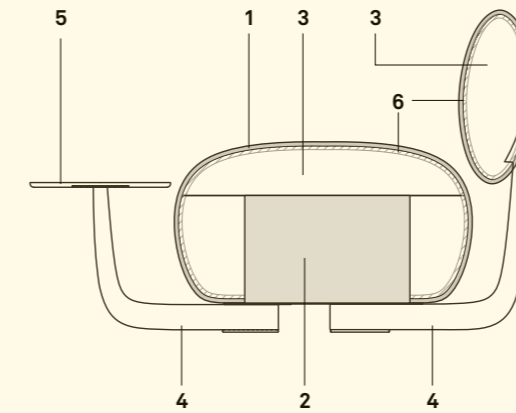
The standard finishing for the top are the two colours shown above. Customized RAL colors are available upon request.

Le finiture standard del piano sono le due colorazioni mostrate qui sopra. Su richiesta sono disponibili colorazioni customizzate su altre tinte RAL.

La finition standard du plateau sont les deux couleurs indiquées ci-dessus. Des couleurs RAL personnalisées sont disponibles sur demande.

## TECHNICAL FEATURES

SPECIFICHE TECNICHE - SPÉCIFICATIONS TECHNIQUES



### 1. Upholstery

Rivestimento  
Revêtement

### 2. Inner polystyrene shell

Struttura interna in polistirolo  
Structure interne en polystyrène

### 3. Flexible hard injection foam

Schiuma poliuretanica flessibile  
Mousse injecté à froid

### 4. Laser cut steel feet

Struttura in acciaio tagliato a laser  
Structure en acier taillée au laser

### 5. Round table Ø30/40 cm in HPL

Tavolini circolari Ø30/40 cm in HPL  
Tables rondes Ø30/40 cm en HPL

### 6. 2 mm water-repellent PVC film

Pellicola 2 mm in PVC idrorepellente  
Film PVC hydrofuge de 2 mm



### Suitable for outdoor use

Adatto all'utilizzo in ambienti esterni  
Adapté à une usage extérieur

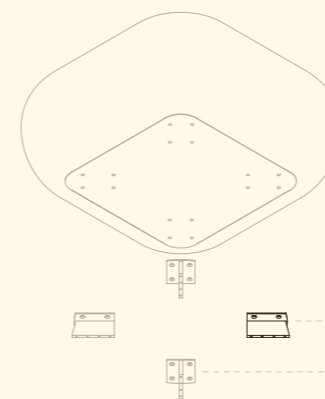
Wooden support, inner polystyrene shell, padded with variable densities cold foam. Covered with 2 mm water-repellent PVC film and upholstered. Round table available in 30 or 40 cm diameter, in HPL. Powder coated laser cut steel feet.

Supporto in legno, struttura in polistirolo imbottito con schiumato a freddo a densità variabile. Rivestimento con una pellicola di 2 mm in PVC idrorepellente e tappezzato. Tavolini circolari di diametro 30 o 40 cm in HPL. Piedi in acciaio tagliato a laser e verniciati a polveri. Per la versione outdoor è presente una pellicola di 2 mm in PVC idrorepellente.

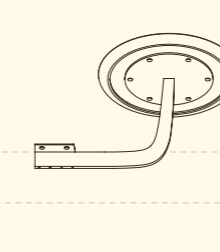
Support en bois, coque intérieure en polystyrène, rembourrée de mousse à froid à densité variable. Recouvert d'un film PVC hydrofuge de 2 mm et rembourré. Petites tables circulaires d'un diamètre de 30 ou 40 cm en HPL. Pieds en acier taillés au laser et revêtus par poudre.

## ACCESSORIES

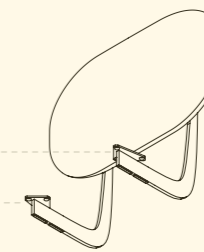
ACCESSORI - ACCESSOIRES



**FEET**  
PIEDINI - PIEDS

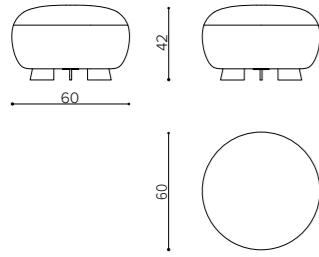


**TABLE**  
TAVOLO - TABLE



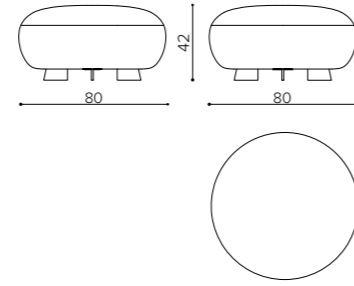
**BACKREST**  
SCHIENALE - DOSSIER

**CD 60RO OUT**  
small round module  
modulo circolare piccolo  
petit module circulaire



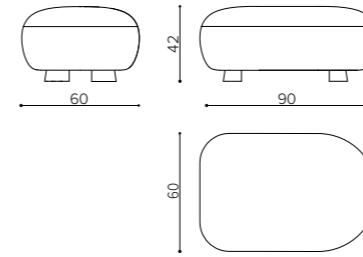
# m 1,3   ♻️ mq 2,2   📦 kg 9   🛠️ mc 0,15

**CD 80RO OUT**  
big round module  
modulo circolare grande  
grand module circulaire



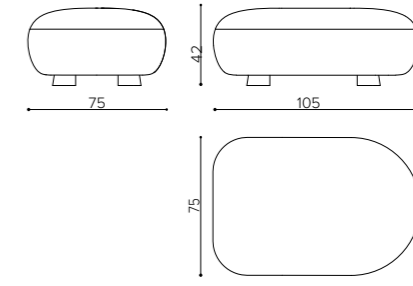
# m 1,8   ♻️ mq 3,5   📦 kg 14,5   🛠️ mc 0,27

**CD 60RE OUT**  
small rectangular module  
modulo rettangolare piccolo  
petit module rectangulaire



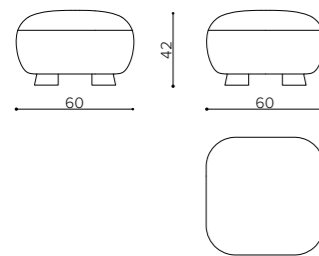
# m 2,1   ♻️ mq 3,7   📦 kg 13   🛠️ mc 0,23

**CD 75RE OUT**  
big rectangular module  
modulo rettangolare grande  
grand module rectangulaire



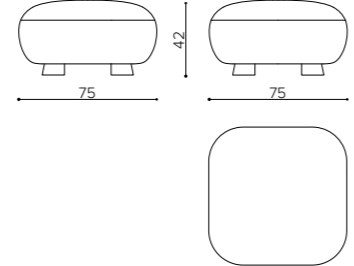
# m 2,1   ♻️ mq 3,7   📦 kg 18   🛠️ mc 0,33

**CD 60SQ OUT**  
small square module  
modulo quadrato piccolo  
petit module carré



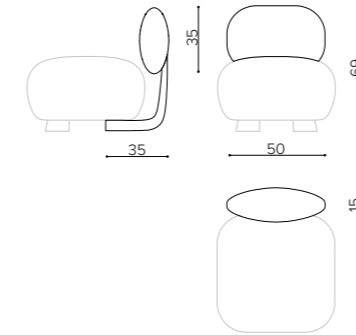
# m 1,7   ♻️ mq 3,2   📦 kg 10,5   🛠️ mc 0,15

**CD 75SQ OUT**  
big square module  
modulo quadrato grande  
grand module carré



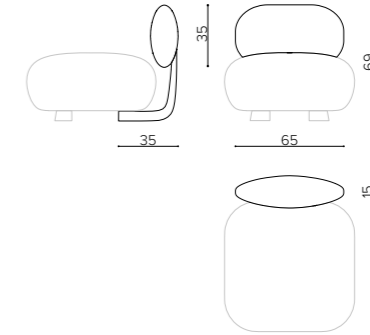
# m 1,7   ♻️ mq 3,2   📦 kg 13   🛠️ mc 0,24

**CD 60BR OUT**  
60cm backrest module for all small versions  
modulo schienale 60cm per tutte le versioni piccole  
module dossier 60cm pour toutes les petites versions



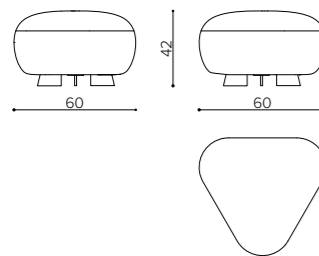
# m 0,85   ♻️ mq 1,15   📦 kg 7   🛠️ mc 0,15

**CD 75BR OUT**  
75cm backrest module module for all large versions  
modulo schienale 75cm per tutte le versioni grandi  
module dossier 75cm pour toutes les grandes versions



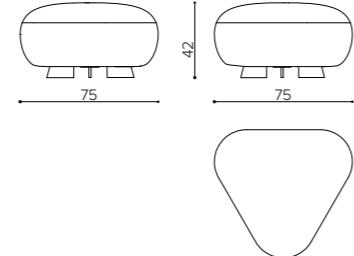
# m 0,85   ♻️ mq 1,15   📦 kg 8   🛠️ mc 0,15

**CD 60TR OUT**  
small triangular module  
modulo triangolare piccolo  
petit module triangulaire



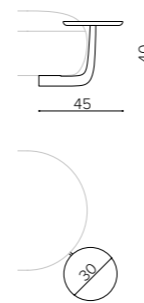
# m 1,7   ♻️ mq 3,2   📦 kg 8,5   🛠️ mc 0,15

**CD 75TR OUT**  
big triangular module  
modulo triangolare grande  
grand module triangulaire



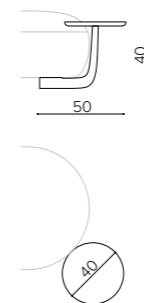
# m 1,7   ♻️ mq 3,2   📦 kg 10,5   🛠️ mc 0,24

**CD TL3R OUT**  
30cm round table  
tavolino circolare 30cm  
table circulaire 30cm



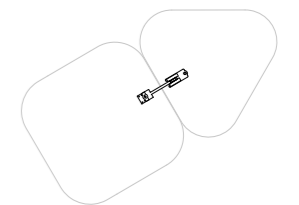
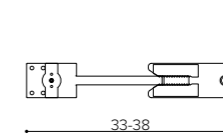
📦 kg 5   🛠️ mc 0,07

**CD TL4R OUT**  
40cm round table  
tavolino circolare 40cm  
table circulaire 40cm



📦 kg 6   🛠️ mc 0,07

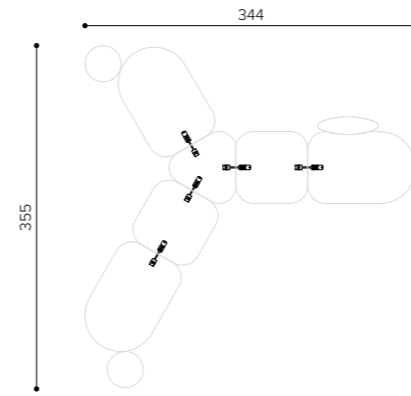
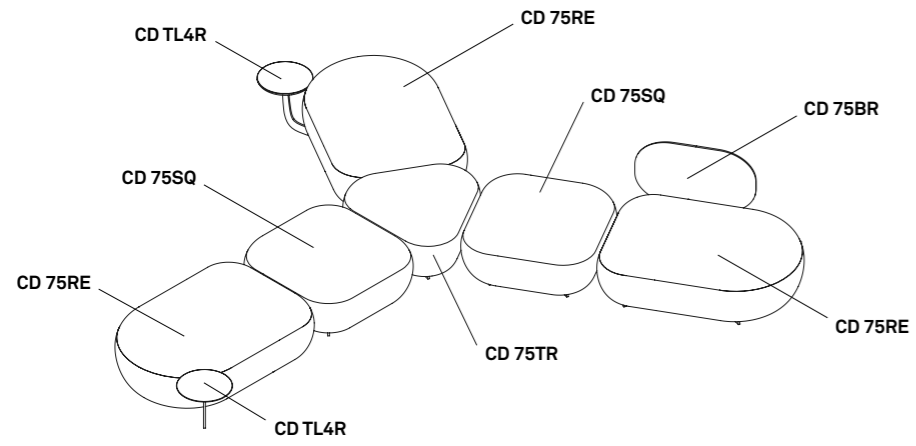
**CD JJ00 OUT**  
Junction element  
Elemento di collegamento  
Élément de connexion



Indicated for one connection for square, rectangular and triangular version  
Indicato per una connessione per versione quadrata, rettangolare e triangolare  
Indiqué pour une connexion pour version carrée, rectangulaire et triangulaire

**CONFIGURATION EXAMPLE 1**

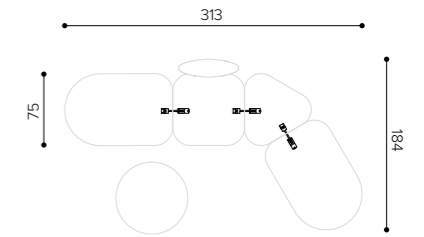
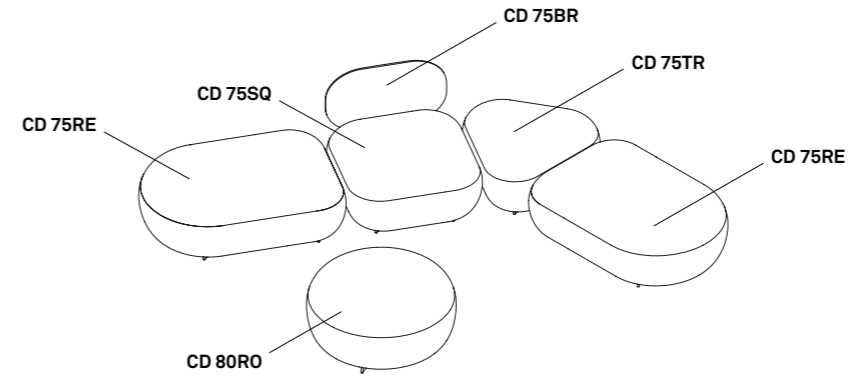
ESEMPIO COMPOSIZIONE 1 - EXEMPLE DE CONFIGURATION 1



344 W x 355 D x 69 H

**CONFIGURATION EXAMPLE 2**

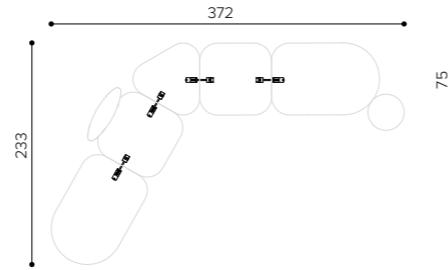
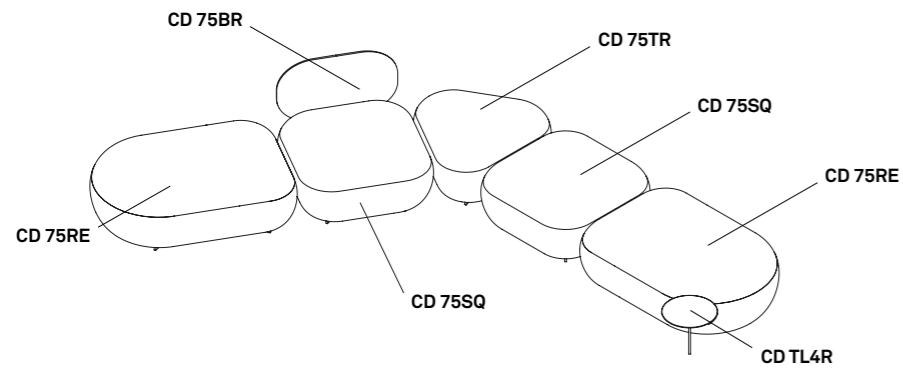
ESEMPIO COMPOSIZIONE 2 - EXEMPLE DE CONFIGURATION 2



313 W x 184 D x 69 H

**CONFIGURATION EXAMPLE 3**

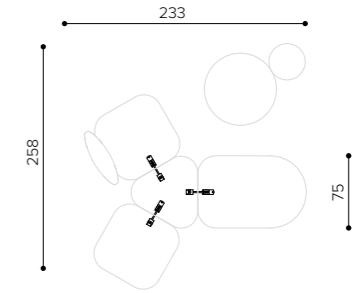
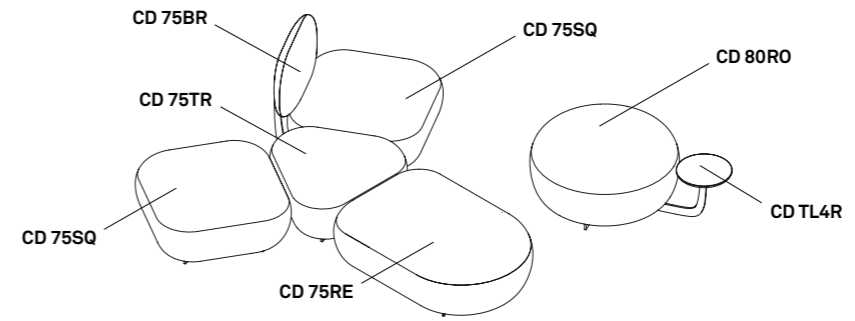
ESEMPIO COMPOSIZIONE 3 - EXEMPLE DE CONFIGURATION 3



372 W x 233 D x 69 H

**CONFIGURATION EXAMPLE 4**

ESEMPIO COMPOSIZIONE 4 - EXEMPLE DE CONFIGURATION 4



258 W x 233 D x 69 H

# UPHOLSTERY CATEGORIES

CATEGORIE RIVESTIMENTI - CATÉGORIES DE TISSUS D'AMEUBLEMENT

S	<b>camira</b>	GRAVITY	76% Polyester, 24% Recycled Polyester, non metallic dyestuffs 76% Poliestere, 24% Poliestere riciclato, coloranti non metallici 76% Polyester, 24% Polyester recyclé, colorants non métalliques
	FIDIVI	LASER N	100% Polyester Trevira CS 100% Poliestere Trevira CS - 100% Polyester Trevira CS
	FIDIVI	ONE	100% Recycled polyester 100% Poliestere riciclato - 100% Polyester recyclé
T	FIDIVI	MAYA	100% Polyester Trevira CS 100% Poliestere Trevira CS - 100% Polyester Trevira CS
	FIDIVI	INCAS	100% Polyester Trevira CS 100% Poliestere Trevira CS - 100% Polyester Trevira CS
	FIDIVI	LASER J & J FLASH	100% Polyester Trevira CS 100% Poliestere Trevira CS - 100% Polyester Trevira CS
M	<b>kvadrat</b>	FIELD 2	100% Polyester Trevira CS 100% Poliestere Trevira CS - 100% Polyester Trevira CS
	FIDIVI	CORTE	100% Polyester Trevira CS 100% Poliestere Trevira CS - 100% Polyester Trevira CS
	<b>camira</b>	MAIN LINE FLAX	70% Virgin Wool, 30% Flax 70% Lana Vergine, 30% Lino - 70% Laine vierge, 30% Lin
	<b>SPRADLING®</b>	VALENCIA	Vinyl / Urethane Topcoat Finitura in vinile / uretano - Revêtement de finition vinyle / uréthane
F	<b>camira</b>	SYNERGY	95% Virgin Wool, 5% Polyamide 95% Lana Vergine, 5% Poliammide - 95% Laine vierge, 5% Polyamide
	<b>kvadrat</b>	REMIX 3	90% New wool (worsted), 10% Nylon 90% Lana vergine (pettinata), 10% Nylon - 90% Laine vierge (peignée), 10% Nylon
L	<b>maharam</b>	MERIT	76% Recycled polyester, 24% Polyester 76% Poliestere riciclato, 24% Poliestere - 76% Polyester recyclé, 24% Polyester
	<b>kvadrat</b>	MEMORY 2	100% Polyester Trevira CS 100% Poliestere Trevira CS - 100% Polyester Trevira CS
	<b>kvadrat</b>	COLLINE 2	75% New wool (worsted), 17% Acrylic, 8% Nylon 75% Lana vergine (pettinata), 17% Acrilico, 8% Nylon 75% Laine vierge (peignée), 17% Acrilico, 8% Nylon
P	<b>DANI</b>	PANAMA GENUINE LEATHER	Chrome tanned european bovine raw hides Pelle bovina europea ai sali di cromo - Cuir de bovin européenne avec sels de chrome
PX	<b>FEBRIK kvadrat</b>	UNIFORM MELANGE	European bovine leather, full grain Pelle pieno fiore, bovina europea - Cuir de bovin européen, pleine fleur
	<b>elmo</b>	BALTIQUE FULL GRAIN LEATHER	European bovine leather Pelle bovina europea - Cuir de bovin européen

# OUTDOOR UPHOLSTERY CATEGORIES

CATEGORIE RIVESTIMENTI OUTDOOR - CATÉGORIES DE TISSUS D'AMEUBLEMENT OUTDOOR

M	<b>SPRADLING®</b>	MAGLIA	Vinyl / Urethane Topcoat Finitura in vinile / uretano - Revêtement de finition vinyle / uréthaneD
F	<b>DELIUS</b> WORLD OF TEXTILES SINCE 1722	GOA	100% Polyolefinic FR 100% Poliolefinico FR - 100% Polyoléfinique FR
	<b>DELIUS</b> WORLD OF TEXTILES SINCE 1722	TONGA	100% Polyolefinic FR 100% Poliolefinico FR - 100% Polyoléfinique FR
L	<b>DELIUS</b> WORLD OF TEXTILES SINCE 1722	ARUBA	100% Polyolefinic FR 100% Poliolefinico FR - 100% Polyoléfinique FR
	<b>DELIUS</b> WORLD OF TEXTILES SINCE 1722	BALI	100% Polyolefinic FR 100% Poliolefinico FR - 100% Polyoléfinique FR
	<b>DELIUS</b> WORLD OF TEXTILES SINCE 1722	HAITI	100% Polyolefinic FR 100% Poliolefinico FR - 100% Polyoléfinique FR

# OUTDOOR USE AND MAINTENANCE

USO E MANUTENZIONE PER L'OUTDOOR - UTILISATION ET MAINTENANCE POUR L'EXTÉRIUR

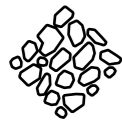


**STEEL**  
METALLO/MÉTAL

Steel is used in the manufacture of metal products. This material galvanised and powder-coated, is ideal for outdoor use. Regarding products intended for seaside locations we recommend cleaning on a quarterly basis, with a cloth using water or mild detergents. During the winter period we recommend storing the furniture in closed, dry rooms in order to prevent condensation. In fact, although our products are suitable for outdoor use, during colder months the products should be stored in a closed, dry place in order to prevent moisture and seasonal frosts from affecting the finish.

Nella realizzazione dei prodotti metallici viene impiegato l'acciaio, il quale in seguito al processo di zincatura e di verniciatura a polveri, risulta ideale per l'utilizzo outdoor. Durante il periodo invernale consigliamo di conservare gli arredi in luoghi chiusi ed asciutti per evitare la formazione di condensa. Per i prodotti destinati a località marittime consigliamo con cadenza trimestrale una pulizia con un panno utilizzando acqua o detersivi non aggressivi. Nonostante i nostri prodotti siano adatti all'ambiente esterno, durante il periodo invernale è consigliato il ricovero dei prodotti in un luogo chiuso ed asciutto. In modo da evitare che l'umidità unita alle gelate stagionali possa in qualche modo intaccare le finiture.

L'acier est la matière première utilisée dans la fabrication de ces produits métalliques qui, après un processus de galvanisation et un revêtement de finition par poudre, sont idéaux pour une utilisation en extérieur. Pour les produits destinés à être utilisés en bord de mer, nous recommandons un nettoyage trimestriel avec un chiffon utilisant de l'eau ou des détergents doux. Bien que nos produits soient adaptés à un usage extérieur, nous recommandons de les stocker dans un endroit fermé et sec pendant l'hiver; ceci afin d'éviter que l'humidité combinée aux gelées saisonnières n'affecte d'une manière ou d'une autre les finitions.



**STONE**  
PIETRA/PIERRE

The stone tops are made of Marble or Quarella and they are ideal for the outdoor environment. Use a soft cloth with just water for daily cleaning. Avoid the use of aggressive abrasive sponges or steel wool pads. The furnishings made of stone such as marble and Quarella, during the first week of use will undergo a slight dulling due to contact with external elements. This is a natural phenomenon which does not affect the quality of the material. When the furniture is placed in seaside locations or swimming pools, cleaning with fresh water on a quarterly basis is recommended in order to avoid water corrosion due to salt build-up or chlorosis. Although our products are suitable for outdoor use, during colder months the products should be stored in a closed, dry place in order to prevent moisture and seasonal frosts from affecting the finish.

Materiale composito autoportante adatto all'ambiente Outdoor. Utilizzare un panno morbido con sola acqua per la pulizia quotidiana. In caso di necessità utilizzare detersivi non aggressivi. Evitare l'impiego di spugne abrasive o pagliette in acciaio. Nel caso di collocamento degli arredi in località marittime o piscine, si consiglia una pulizia trimestrale utilizzando acqua dolce per evitare principi di corrosione dovuti ad accumuli salini o clorosi. Nonostante i nostri prodotti siano adatti all'ambiente esterno, durante il periodo invernale è consigliato il ricovero dei prodotti in un luogo chiuso ed asciutto. In modo da evitare che l'umidità unita alle gelate stagionali possa in qualche modo intaccare le finiture.

Les dessus en pierre sont en marbre ou en quarella, idéaux pour une utilisation en extérieur. Utilisez un chiffon doux avec de l'eau uniquement pour le nettoyage quotidien. Évitez d'utiliser des détergents agressifs, des éponges abrasives ou des tampons de laine d'acier. Les meubles en pierre tels que le marbre et la Quarella, pendant la première semaine, subissent un léger ternissement dû au contact avec les éléments extérieurs. Il s'agit d'un phénomène naturel, qui n'affecte pas la qualité du matériau. Si le meuble est placé dans des stations balnéaires ou des piscines, nous recommandons un nettoyage trimestriel à l'eau douce pour éviter la corrosion due à l'accumulation de sel ou à la chlorose. Bien que nos produits conviennent à une utilisation en extérieur, il est recommandé, pendant la période hivernale, de stocker les produits dans un endroit fermé et sec, afin d'éviter que l'humidité combinée aux gelées saisonnières n'affecte d'une manière ou d'une autre la finition.

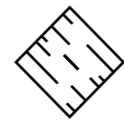


**FABRICS**  
PIETRA/TISSU

The fabrics used are naturally resistant to climatic elements, UV-resistant and anti-microbial. After heavy rainfall it is recommended to remove the cushions for quick drying and in order to prevent condensation. When the furniture is placed in seaside locations or swimming pools, cleaning with fresh water on a quarterly basis is recommended in order to avoid water corrosion due to salt build-up or chlorosis. Although our products are suitable for outdoor use, during colder months the products should be stored in a closed, dry place in order to prevent moisture and seasonal frosts from affecting the finish.

I tessuti impiegati sono naturalmente resistenti agli elementi climatici, resistenti ai raggi UV ed anti-microbici. A seguito di forti precipitazioni è consigliato rimuovere i cuscini per un'asciugatura rapida e prevenire la formazione di condensa. Nel caso di collocamento degli arredi in località marittime o piscine, si consiglia una pulizia trimestrale utilizzando acqua dolce per evitare principi di corrosione dovuti ad accumuli salini o clorosi. Nonostante i nostri prodotti siano adatti all'ambiente esterno, durante il periodo invernale è consigliato il ricovero dei prodotti in un luogo chiuso ed asciutto. In modo da evitare che l'umidità unita alle gelate stagionali possa in qualche modo intaccare le finiture.

Les tissus utilisés sont naturellement résistants aux éléments climatiques, résistants aux UV et antimicrobiens. Après de fortes pluies, il est toutefois conseillé de retirer les coussins pour un séchage rapide et pour éviter la formation de condensation. Si le mobilier est placé dans des stations balnéaires ou des piscines, nous recommandons un nettoyage trimestriel à l'eau douce pour éviter la corrosion due à l'accumulation de sel ou de chlore. Bien que nos produits soient adaptés à une utilisation en extérieur, il est recommandé de les stocker dans un endroit fermé et sec pendant la période hivernale, afin d'éviter que l'humidité combinée aux gelées saisonnières n'affecte d'une manière ou d'une autre les finitions.



**HPL**  
HPL/HPL

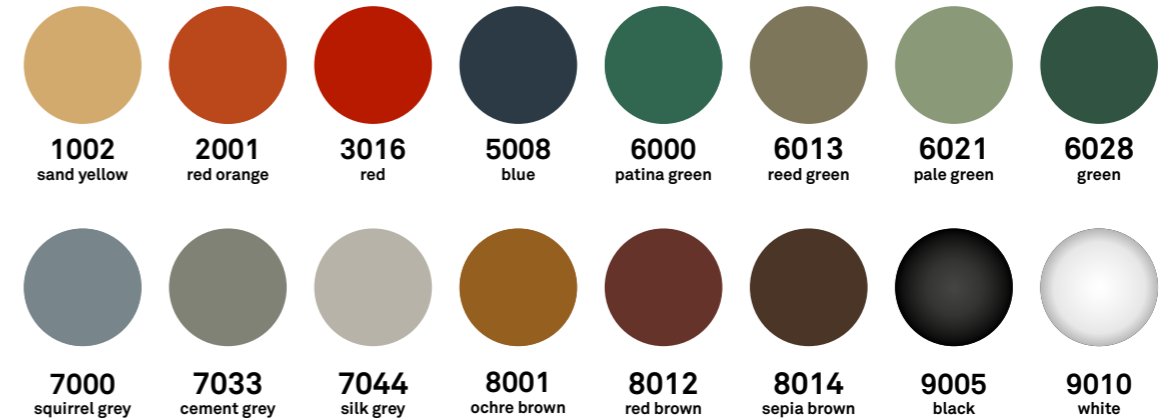
Self-supporting composite material suitable for outdoor environment. Use a soft cloth with water only for daily cleaning. If necessary, use non-aggressive detergents. Please avoid using abrasive sponges or steel wool pads. When the furniture is placed in seaside locations or swimming pools, cleaning with fresh water on a quarterly basis is recommended in order to avoid water corrosion due to salt build-up or chlorosis. Although our products are suitable for outdoor use, during colder months the products should be stored in a closed, dry place in order to prevent moisture and seasonal frosts from affecting the finish.

Materiale composito autoportante adatto all'ambiente Outdoor. Utilizzare un panno morbido con sola acqua per la pulizia quotidiana. In caso di necessità utilizzare detersivi non aggressivi. Evitare l'impiego di spugne abrasive o pagliette in acciaio. Nel caso di collocamento degli arredi in località marittime o piscine, si consiglia una pulizia trimestrale utilizzando acqua dolce per evitare principi di corrosione dovuti ad accumuli salini o clorosi. Nonostante i nostri prodotti siano adatti all'ambiente esterno, durante il periodo invernale è consigliato il ricovero dei prodotti in un luogo chiuso ed asciutto. In modo da evitare che l'umidità unita alle gelate stagionali possa in qualche modo intaccare le finiture.

Matériau composite autoportant adapté à un usage extérieur. Utilisez un chiffon doux avec de l'eau uniquement pour le nettoyage quotidien. Si nécessaire, utilisez des détergents non agressifs. Évitez d'utiliser des éponges abrasives ou des tampons de laine d'acier. Si le mobilier doit être installé dans des stations balnéaires ou des piscines, nous recommandons un nettoyage trimestriel à l'eau douce pour éviter la corrosion due au sel ou au chlore. Bien que nos produits conviennent à une utilisation en extérieur, il est recommandé, pendant la période hivernale, de stocker les produits dans un endroit fermé et sec, afin d'éviter que l'humidité combinée aux gelées saisonnières n'affecte d'une manière ou d'une autre les finitions.

# STANDARD STEEL RAL COLORS

COLORI RAL STANDARD PER ACCIAIO - COULEURS RAL STANDARD POUR L'ACIER



The standard finishings for the steel elements are the RAL shown. Customized RAL colors finishings are available upon request.

Le finiture standard degli elementi in acciaio sono i RAL mostrati. Su richiesta sono disponibili colorazioni customizzate su altre tinte RAL.

Les finitions standard des éléments en acier sont le RAL illustré. Des couleurs RAL personnalisées sont disponibles sur demande.



# COLOR SWATCHES AND TECH INFO

CAMPIONI COLORI E INFO TECNICHE - ÉCHANTILLONS DE COULEURS ET INFOS TECHNIQUES

## DOWNLOAD

Click on the image above to download the color swatches and technical informations

Clicca sull'immagine per scaricare il pdf dei campioni colori e specifiche tecniche

Cliquez sur l'image ci-dessus pour télécharger les échantillons de couleurs et les informations techniques

